

EASY-LASER[®]

www.easylaser.com

XT770



Know your machine from every angle.

Shaft Alignment

XT770



IP66
IP67



CLOUD
CONNECTED

MEASUREMENT INDEPENDENCE

EASY-LASER® GENERATION XT

Easy-Laser® XT770 is the most powerful amongst our Generation XT shaft alignment systems. Built upon our ground-breaking cross-platform technology, it is giving you the freedom to work with the display unit that suits you and the job best. Simply download our straightforward XT application for free and you have all the measurement programs you need.

NO LOCK-INS

With Generation XT you decide if you want the rugged and user-friendly Easy-Laser® XT12 display unit to be included or not. The app also runs on your iOS® or Android® device*, be it a tablet or a phone, meaning you are never locked in to a specific way of working.

NO LICENSE HASSLE

Your Generation XT measuring units determine what functions are available. No hassle with licenses, just connect the units to the app, on any of your display devices, and start measuring. That is straightforward!

SAME INTERFACE

Purchase multiple systems with various capabilities, train once! The training costs are minimized significantly since the app interface and basic functionality is identical for all XT systems; XT440, XT550 Ex, XT660, XT770, XT290, XT280, XT190.

MAXIMUM FLEXIBILITY!

The XT Alignment app runs on iOS and Android devices, as well as on the Easy-Laser® XT12/XT11 display unit. The choice is yours.*



Download on the
App Store



GET IT ON
Google Play



RUN IT ON
EASY-LASER XT 11/12

*Conditions apply

HIGHLIGHTS

MAXIMUM FLEXIBILITY



ALL XT PROGRAMS IN ONE FREE APP

All XT measurement programs included in one straightforward application available for free.



DISPLAY DATA ON MULTIPLE PLATFORMS

Functionality for iOS, Android and Easy-Laser® XT display units.



NO LOCK-INS

Buy with or without the user-friendly Easy-Laser® XT12 display unit.



MAXIMUM FLEXIBILITY

Combine several measuring units with the display unit of your choice, or use different display units with one set of measuring units. No license hassle!



RUGGED DESIGN

The XT products are rugged, rated both IP66 and IP67 water and dust proof. For superior durability in harsh environments.



LONG OPERATING TIMES

The long operating times of up to 16 hours for the display unit and 24 hours for the measuring units mean even the toughest jobs will be finished on time with no interruptions.



SEND THE REPORTS

Share the reports via email. Possible on all platforms.

RUGGED DESIGN



IP66 AND IP67 APPROVED

Easy-Laser® XT measuring units and display unit are waterproof, dustproof and shockproof. The units have been tested and approved to an Ingress Protection rating of IP66 and IP67, which means that they are dustproof and waterproof to a depth of 1 metre, and also protected against powerful water jets.



(Note: Photo shows XT60 measuring unit.)

THIS IS EASY ALIGNMENT

HORIZONTAL PROGRAM



The user interface is intuitive and guides you through the measurement process. It is animated and zooms in to the relevant element for each step. You can save the measurements of a machine for *As found* and *As left* in the same file.

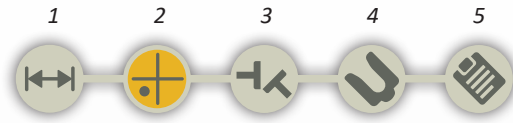

The interactive workflow indicator lets you easily jump to any part in the measurement process.

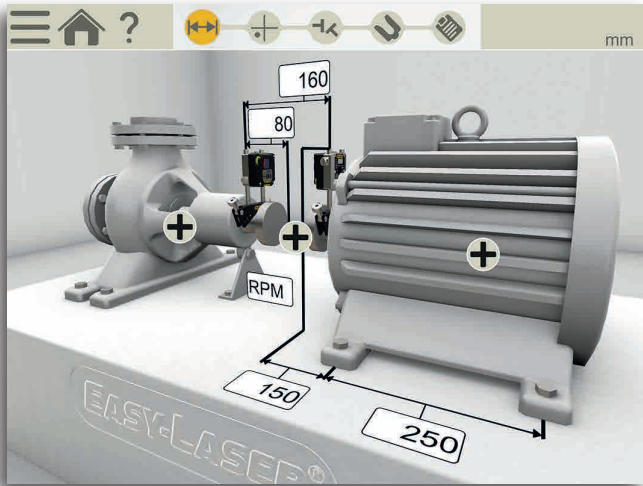

1. Enter dimensions

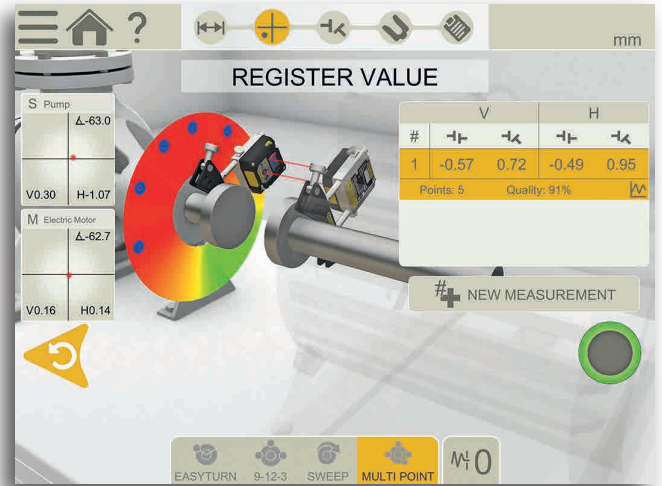

2. Measure (Five methods available, explained to the right)

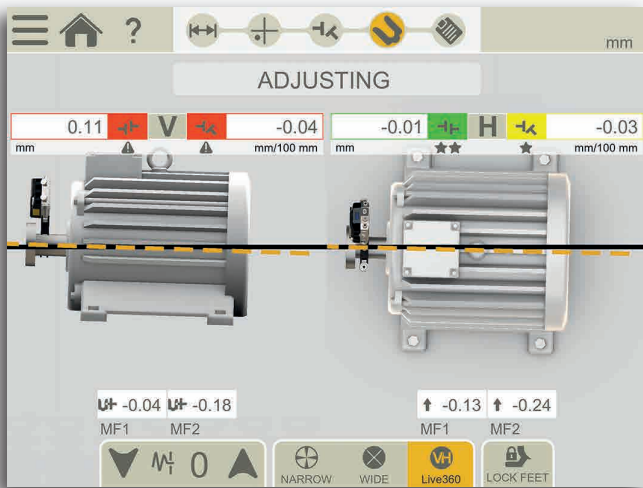

3. View result, *As found*
4. Adjust



5. View report as it will look

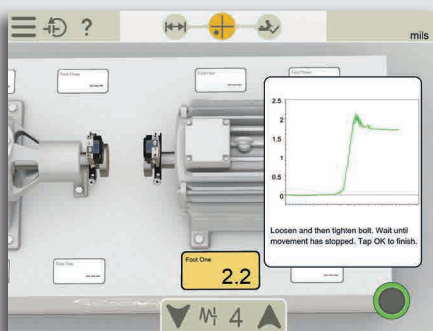

Soft Foot check on both machines

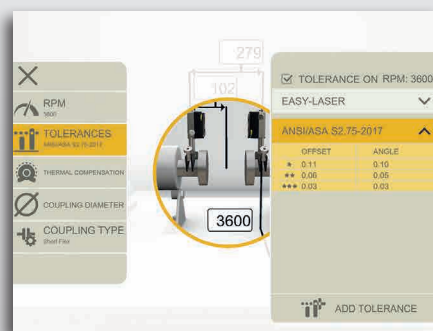

Tolerance check (pre-set or custom)

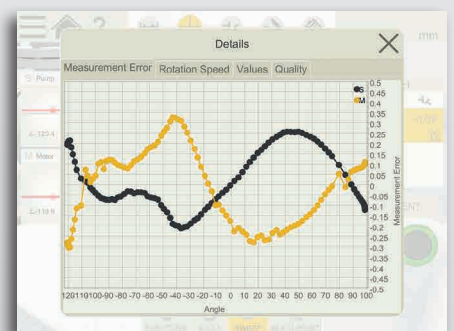

Quality check view for measurements

MEASUREMENT METHODS

● Measuring points

⊙ Start recording

◼ Stop recording

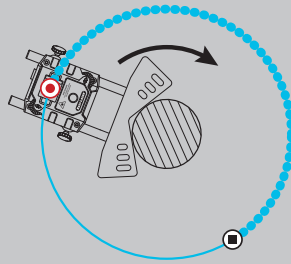

CONTINUOUS SWEEP

Automatic recording of measurement values during continuous sweeping of the shaft. The easiest and quickest way to obtain the alignment status on coupled machines. Hundreds of points are registered. Start recording, rotate, and stop at any angle and you get the results instantly. Quality check of measurement is provided (see example down left).

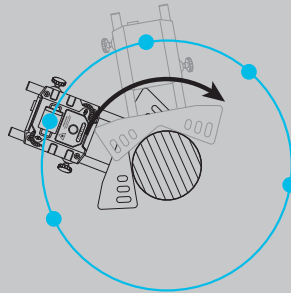

UNCOUPLED SWEEP

Used when the machines are uncoupled and when the rotation can be difficult to control. Rotate one shaft/unit at a time to pass with the beam over the other (stationary). Repeat alternately until enough measurement points are recorded. You can start and stop anywhere on the turn. Use it for big heavy machinery like gas turbines, wind turbines or gear boxes which can be difficult to rotate to a specific position.

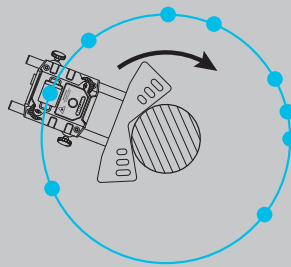

MULTI POINT

Multi point is basically the same as EasyTurn™, but instead you can record multiple points on the sector rotated. This will provide an optimized calculation basis. Perfect for e.g. turbine and sliding bearing applications.

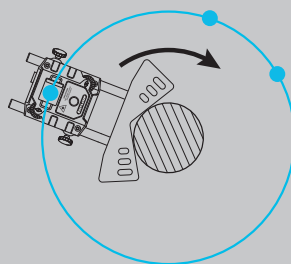

EASYTURN

Ideal method for coupled machines where you manually rotate the shafts to any position. The EasyTurn™ function allows you to begin the measurement process from anywhere on the turn. You can turn the shaft to any three positions with as little as 20° between each position to register the measurement values. An easier-to-use version of the three-point method (see 9-12-3).

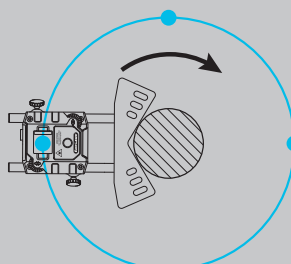

9-12-3

Measurement points are recorded at fixed points 9, 12 and 3 o'clock. This is the classic three-point method which can be used in most cases. The preferred method for situations where the machine to be aligned is mounted on a moving object, and it is not possible to use the inclinometers (e.g., on ships, cranes, wind turbines etc.)

SMART FUNCTIONS



THERMAL GROWTH

Automatically compensate for thermal expansion of the machines.



SWAP VIEW

Understand adjustment directions more intuitively.



CONTINUE SESSION

Your latest measurement is always available, automatically saved.



TEMPLATES

Save measurement files as templates, with machine data and settings, to quickly start measurements.



MEASUREMENT VALUE FILTER

Improve readings when measuring conditions are poor.



MULTIPLE SETS OF FEET

Align machines with more than two pairs of feet.



LOCKED FEET

Lock any pair of feet on the machine. Used when aligning base-bound or bolt-bound machines.



WIDE LIVE ADJUSTMENT

Adjust with live values using expanded sensor position ranges in the H and V position

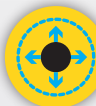

360° LIVE ADJUSTMENT

Adjust both vertically and horizontally at the same time with measuring units in any position.



SELECT COUPLING TYPE

Choose method depending on coupling type: short flex, spacer shaft.



SELECT MACHINE IMAGE

Choose from different 3D machines to portray your machinery on either side of coupling.



ADJUSTMENT GUIDE

The adjustment guide helps you decide optimum adjustment by simulating shimming and move. For programs Horizontal and Machine train.



BUILT-IN HELP

The app includes a searchable *Users Manual* which opens the relevant chapter depending where in the process you are. This makes it quick and easy to find the answer to your user questions.

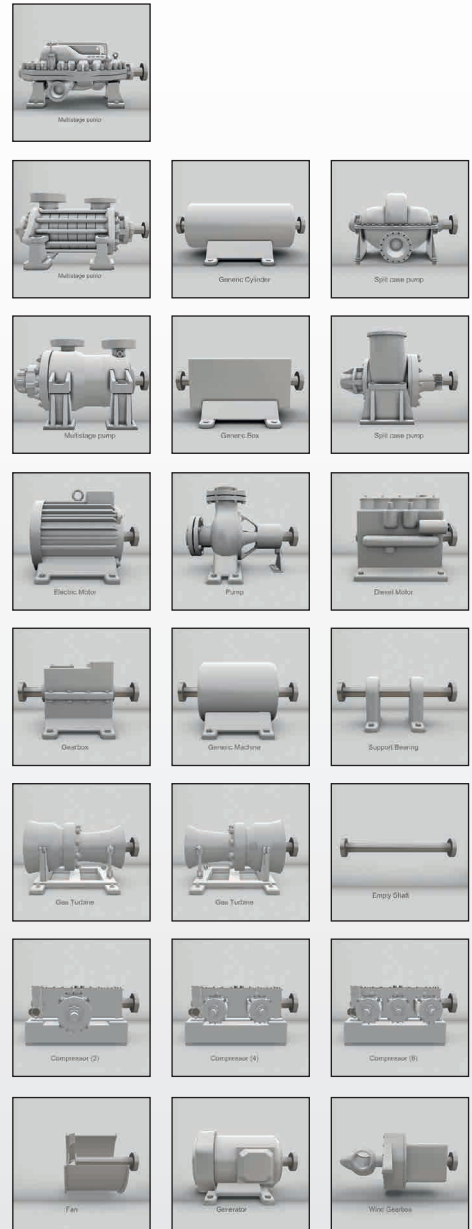

Customize your machine set up in Machine Train and Horizontal programs with corresponding 3D machine icons.

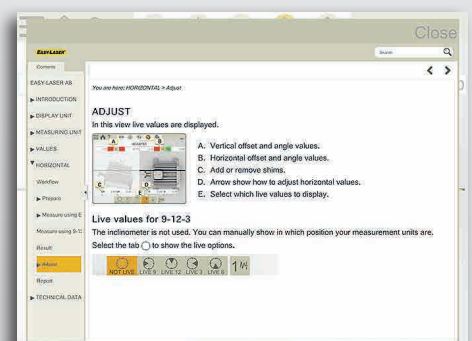

DOCUMENTATION

SAVE!



INTERNAL MEMORY

Save your measurement files, photos and reports to the internal memory.



VERSATILE FILE TYPES

Both a PDF and an Excel file are generated.



READ QR AND BAR CODES

Assign a specific code to a specific machine, then use the built-in camera of your device to open assigned file and settings.

(Note: camera resolution requirements applicable.)

SHOW!



PDF REPORT TEMPLATES

Use one of the two formats included.



ADD NOTES

Explain it a little more.



SIGN REPORTS ELECTRONICALLY

Sign-on screen to verify your job. Signature is saved with the PDF file.



ADD PHOTO

Show what you mean.



ADD THERMAL IMAGE

See the difference after alignment.
(Available only with XT12 Part No. 12-1292)

TYPE	NAME	DATE	Edit
+	Shaft_2018-02-14_14_21_05	2018-02-14	✎
V 0.00 H 0.00	Values_2018-04-10	2018-04-10	✎
📷	IMG_20180410_142801	2018-04-10	
+	Shaft Alignment Water pump 3	2018-04-10	✎
+	Vertical motor ABB	2018-04-14	✎

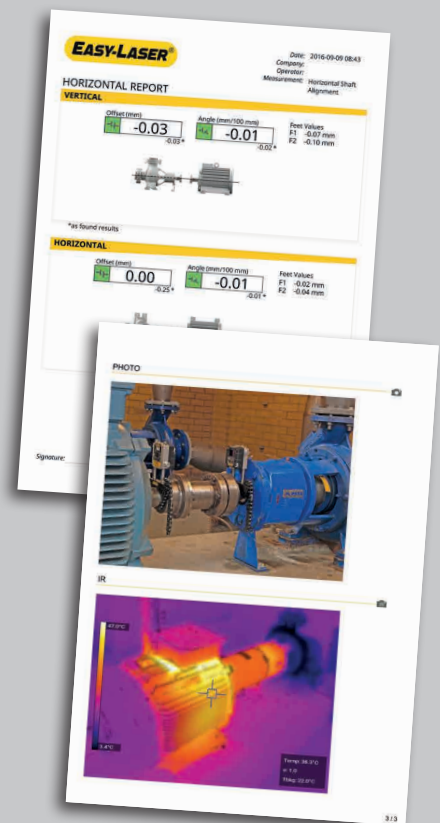

SHARE!



SEND THE REPORTS

Share the reports via email. Possible on all platforms.



SAVE TO USB

Save your files to USB stick and copy to other devices.



MORE POSSIBILITIES

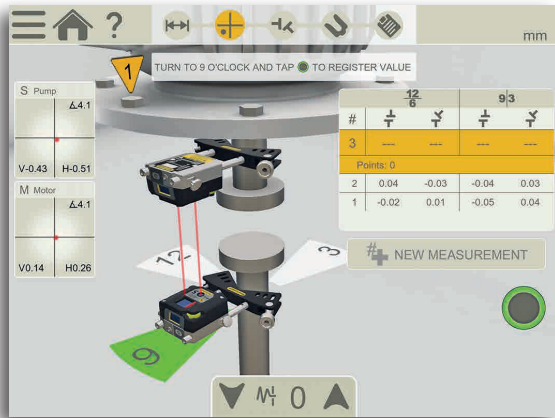

VERTICAL/FLANGE MOUNTED MACHINES



For measurement and alignment of vertically and flange mounted machines. Handles machines with 4, 6, 8 and 10 bolts.

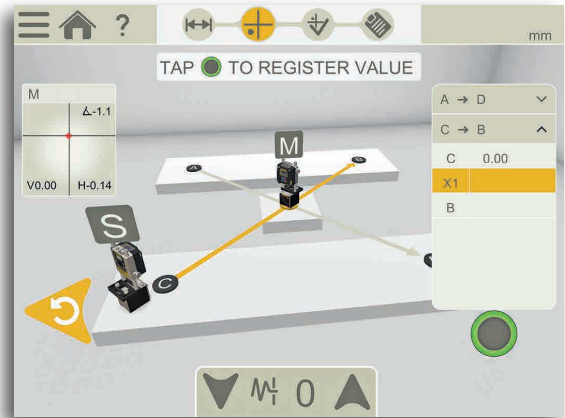

TWIST MEASUREMENT OF MACHINE BASE



The twist measurement program allows you to check the flatness or twist of the machine foundation using only the measuring units in the system.

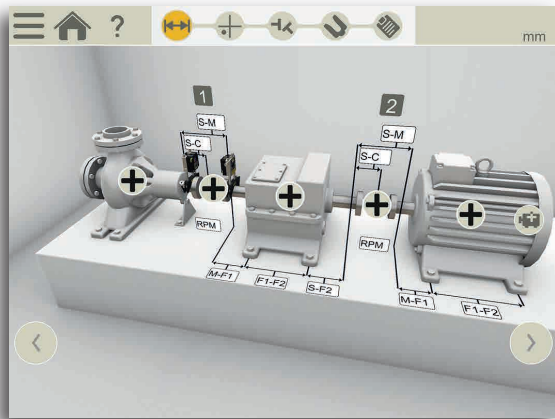

MACHINE TRAIN



Build your own machine train without limits. You can pick the reference machine manually, or let the program choose one that will minimize the need for adjustments.

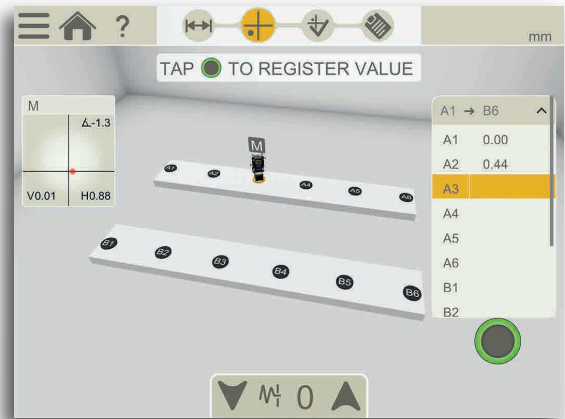

BASIC FLATNESS



With this program you can check the flatness of foundations and frames, using two rows of points, 2 to 8 points per row. (Requires XT20 or XT22).

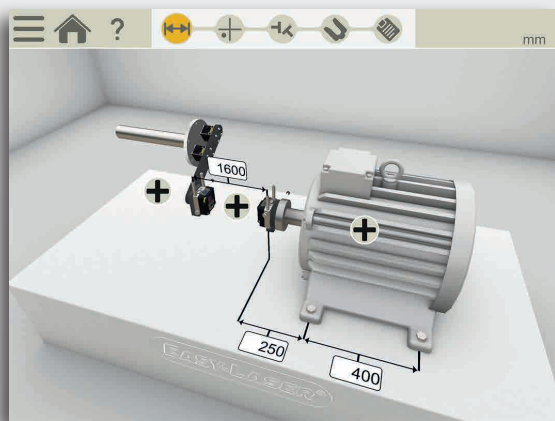

CARDAN/OFFSET MOUNTED MACHINES



For alignment of cardan/offset mounted machinery. (Requires additional Cardan bracket Kit.)

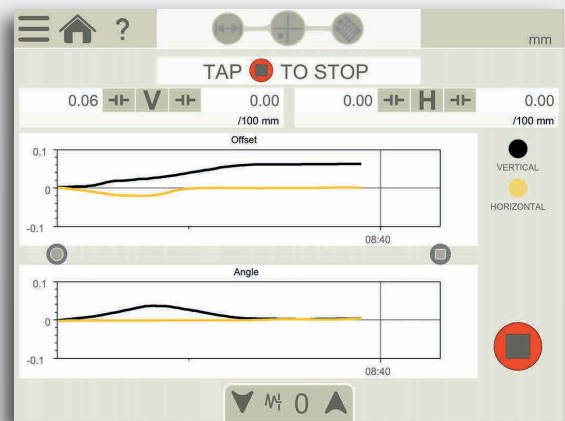

EASYTREND



With EasyTrend you can keep track of machine movement over time. For example, you can check for thermal expansion and pipe strain issues. (Requires additional DM-brackets.)

VERSATILITY

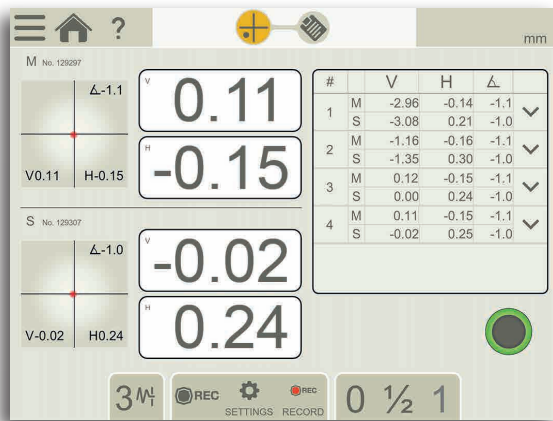

VALUES – DIGITAL DIAL INDICATOR

V 0.00
H 0.00

With the Values program you measure as with dial gauges, but with laser precision and the possibility to document the measurement result.

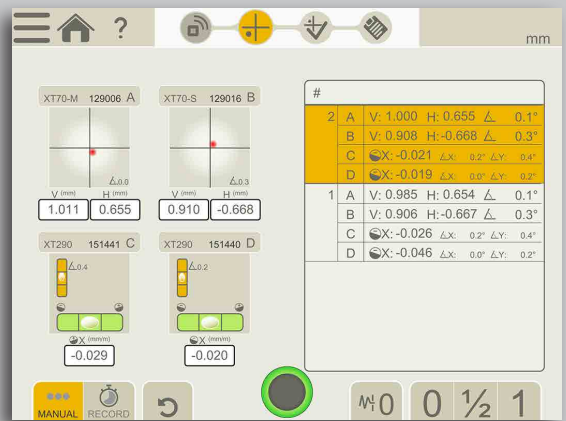

COMBINED DISPLAY

The Values interface can show up to four units at the same time. It can be both measuring units and digital levels, for example. Automatic recording is possible (set the interval and duration). You can make individual notes for each measurement point.

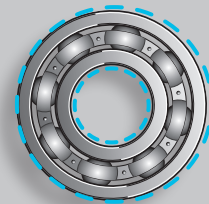

CHECK FOR PLAY AND MOVEMENTS

Mount the M and S units on suitable places, then push/pull the object and check actual machine component play and movements, for example shaft radial play. Laser transmitter XT20/XT22 can also be used.

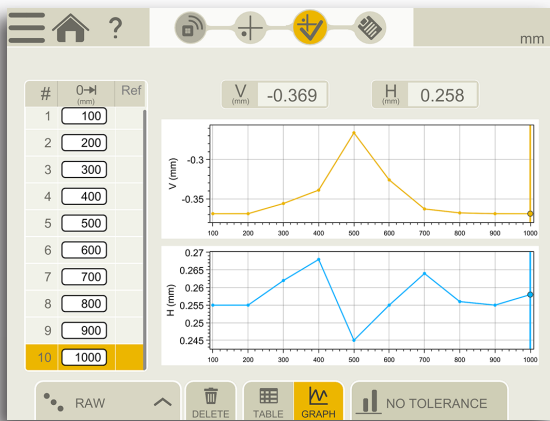
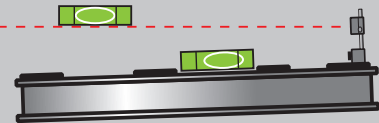

STRAIGHTNESS



With our program for measuring straightness, you can easily measure long shafts, rolls, bearing journals, bases, overhead rails, machine structures etc. You will be able to get the result for both the horizontal and vertical alignment, graphically as well as digitally. The program automatically calculates different Best-fit results. (Requires D75, XT20 or XT22).

BORE CENTER



Use this program to measure the straightness of bore center line, bearing journals and other cylindrical objects. Measure 3–50 points at each position (Multipoint). If required, you can set tolerances. The result can be displayed as Best-fit calculated. Individual points can be remeasured. (Requires XT Bore bracket kit).

GEOMETRICAL MEASUREMENTS

Actually, the program can be used for most geometrical measurements (with suitable units and brackets). Perfect for the complete machine installation phase. For example, with the XT20/XT22 laser transmitter you can use the program to level machine foundations, align several objects co-planar etc.



DYNAMIC MEASUREMENT

Use Values to determine that foundations are rigid enough for the forces applied during running conditions. For measurements where the EasyTrend program is not suitable, or where a laser transmitter should be used instead.

MEASURING UNITS

XT70-M/S MEASURING UNITS

The XT70 measuring units utilize dot-type laser and 2-axis square PSD surfaces. A state-of-the-art OLED display (D) shows the angle of the unit, making it easier to position it on the shaft.

The diagonally positioned locking knobs securely lock the unit on the rods. Rigid aluminium housing provide maximum stability. IP66 and 67, dust- water- and shockproof. Heavy-duty battery for very long operating times; up to 24 hours. Built-in wireless technology.

SHAFT BRACKET

The V-bracket is light yet rigid, with two rods for maximum stability in all directions. Pre-mounted chain for quick setup on the machine.



- A. PSD aperture
- B. Laser aperture
- C. Laser angle adjustment
- D. OLED display: battery status/unit angle
- E. Chain tightening knob
- F. Charger connector
- G. Extendable stainless steel rods
- H. Locking knob
- I. Slidable target/dust cover

DOT-TYPE LASER TECHNOLOGY

The dot laser technology makes it possible to measure larger machines and longer spans than line laser systems. It also provides higher accuracy when backlash in the coupling is present. In addition, dot laser allows you to check more things when installing a machine, e.g. twist of foundation and bearing clearance. With 2-axis PSD you can read off and record values for both vertical and horizontal directions.



DUAL LASERS, PSD, INCLINOMETERS

With electronic inclinometers in both measuring units the system knows exactly how they are positioned. This also makes it very easy to align uncoupled shafts. The so-called reversed measurement method with two laser beams and two PSD makes it possible to also measure grossly misaligned machines when the lasers fall outside the measuring range of the detectors. This is particularly good for new installations, where the machines are not yet in the correct position. With the Dual Technology, measurement accuracy is retained even over longer distances.



SHAFT BRACKETS

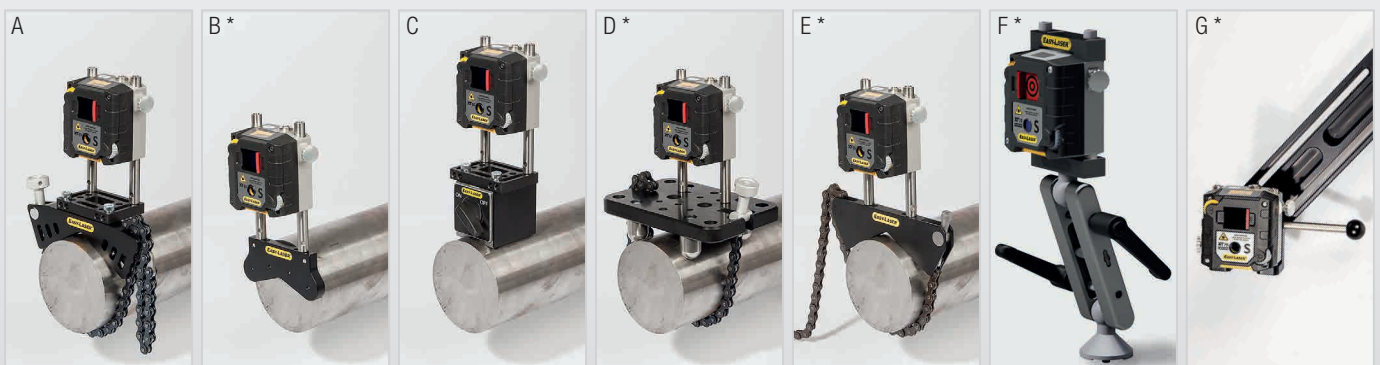

- A. Offset bracket, 2 pcs included
- B. Magnetic bracket*
- C. Magnet base, 2 pcs included
- D. Sliding bracket, Part No. 12-1010*
- E. Thin shaft bracket, Width 12 mm [0.5"], Part No. 12-1012*
- F. DM-bracket. For dynamic measurements. Complete kit with 2 brackets, Part No.12-1130*
- G. Cardan bracket kit, Part No. 12-1151* (Note: not all parts included shown on picture.)
- H. Extension rods (not pictured):
 - Length 30 mm [1.18"], (x1) Part No. 01-0938
 - Length 75 mm [2.95"], (x4) Part No. 12-1161
 - Length 120 mm [4.72"], (x8) Part No. 12-0324
 - Length 240 mm [9.44"], (x4) Part No. 12-0060

*Accessories

DISPLAY UNIT

XT12 DISPLAY UNIT

Rugged, robust, industrial grade tablet with wear resistant rubberized protective coating. IP66 and 67, dust- water- and shockproof. As standard a 13 MP camera for documentation is built-in, but you can also choose a model with IR camera added. With this you can shoot a thermal image before and after alignment and include with the documentation!

A large 8", glove-enabled touch-screen makes the information clear and the app easy to use. You can check battery status also when the unit is turned off.

Heavy-duty rechargeable battery for very long operating times; up to 16 hours. Fastening points for shoulder strap (included).



- A. Ergonomically, rubber coated housing
- B. Battery status-check button
- C. Battery status indicators
- D. Dust cover and protection for connectors
(Note: connectors are dust and waterproof)
- E. Proximity sensor
- F. Display brightness sensor
- G. Large and clear 8" glove-enabled touch-screen
- H. Enter button

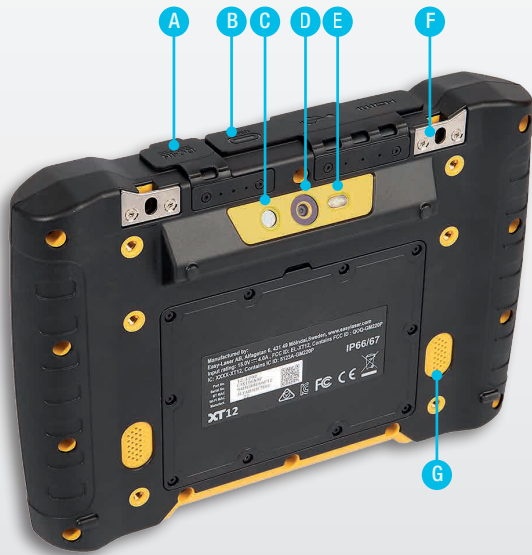

- A. Charger
- B. USB C / USB A / AV connector (HDMI)
- C. IR Camera (optional)
- D. 13 Mp Camera
- E. LED Light
- F. Fastening points for shoulder strap (x2)
- G. Loudspeakers



THERMAL CAMERA

The Easy-Laser® XT12 can be delivered with a thermal imaging camera (IR) along with the standard 13 MP digital camera. Shoot a thermal image before and after alignment and include with the documentation!



13 MP CAMERA

Take pictures to identify your machines and include with your report.



LED LIGHT

Light up the work area when ambient light is not enough.

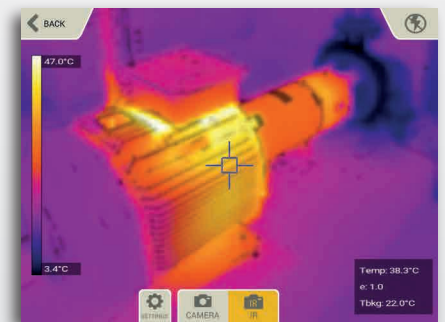

AV CONNECTOR

As standard the XT12 is equipped with a HDMI connector, making it possible to share the display screen direct on a TV monitor or projector screen without any additional software. Useful for training purposes with large groups.

PRECISION LEVEL

FOR GENERAL MACHINERY SET-UP



XT290 Digital Precision Level is the must-have addition to your shaft system. Installing machinery level is very often a requirement for them to work as intended. Use the XT290 as a separate tool, or with the *XT Alignment App*. When connected to the *XT Alignment App* on your iOS or Android device, or the XT12 display unit, you can read off the alignment “live” at the position on the machine where the actual alignment is made, and make PDF reports.

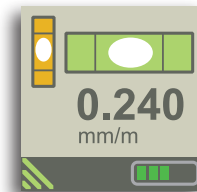
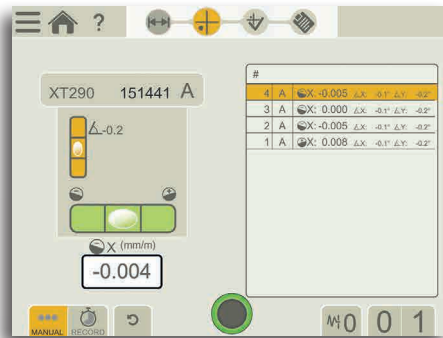

Display on Precision Level unit. Live values and graphics.

Align in live mode, document result with PDF. (*XT Alignment app Values/Level application.*)

SYSTEM XT290 LEVEL PART NO. 12-1244

BELT ALIGNMENT TOOL

FOR RADIALLY MOUNTED DRIVES



With the Belt alignment tool XT190 BTA you can align most types of radially mounted drives. The transmitter and detector attaches magnetically to the sheave edge. A digital display unit gives the advantage of checking against belt manufacturer tolerances.

When connected to the *XT Alignment App* on your iOS or Android device, or the XT12, you can also read off the alignment “live” at the position on the machine where the actual alignment is made. You get adjustment values for both horizontal and vertical direction (shim value), resulting in a more accurate alignment in a shorter time.

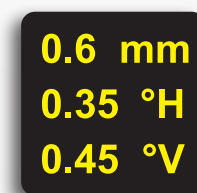
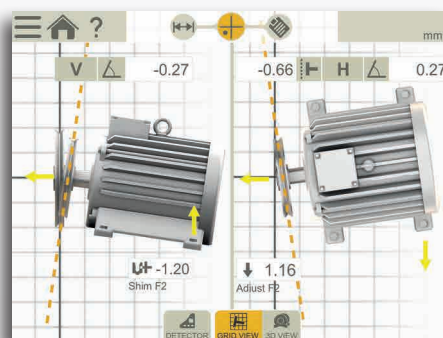

OLED display on detector unit. Live values.

Align machine in live mode, document result with PDF. (*XT Alignment app Belt application.*)

SYSTEM XT190 BTA
PART NO. 12-1053



VIBROMETER TOOL

FOR QUICK VIBRATION ANALYSIS



Easy-to-use vibration analyser that quickly diagnose vibration level, unbalance, misalignment and looseness. The direct readout of 1x, 2x, 3x RPM, total level as well as bearing condition provide necessary information during installation and alignment. The XT280 connects to the *XT Alignment App*, making it possible to document the result as PDF.

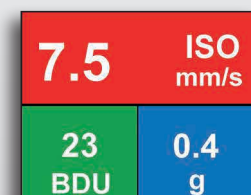
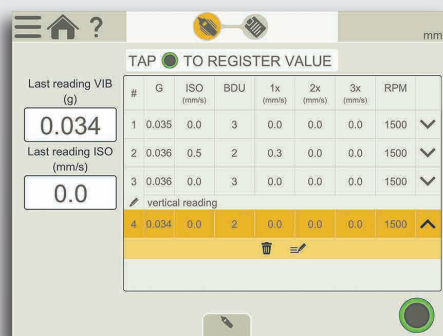

Display on vibrometer unit. Live values.

Register values with notes for each point, add photo of machine, document result with PDF.

SYSTEM XT280 VIB PART NO. 12-1090

GEOMETRIC MEASUREMENTS

STRAIGHTNESS AND FLATNESS

GEO

With XT770 GEO you will be able to measure flatness and straightness according to established standards like ISO and ANSI.

Choose between laser transmitter XT20 or XT22. The kit also includes a magnet base with rotatable top for geo measurements.

SMART TECHNOLOGY

Both transmitters have a 360° rotatable laser head. XT22 can in addition also point the laser beam vertically. Their unique digital precision levels mean the accuracy will not be affected by user interpretation or possible bad work light conditions.

The transmitters connect to the XT Alignment App, making them very easy-to-use. For example you are guided on-screen when calibrating the electronic levels. This makes the procedure easy also for users less experienced of flatness measurement. You can of course also measure with an object as reference instead of the level. The Straightness and Flatness programs then also guide you and make optimized calculations of best-fit for you. Actually, with the Values program you can perform almost any kind of geometrical measurement, although you might need to do some manual calculations.

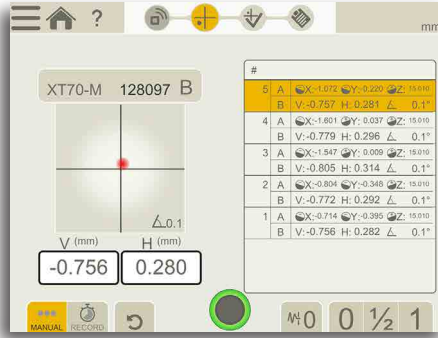

Values program. Gives you absolute values for maximum flexibility.

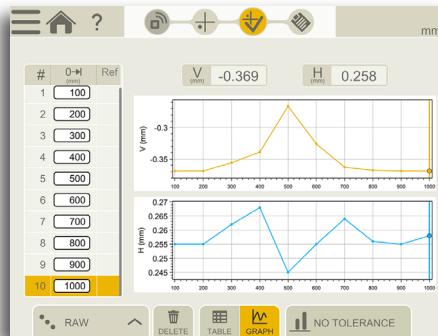
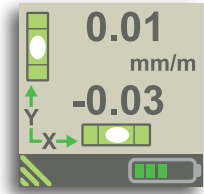

Straightness program. With both H and V values. Add reference points, calculate best-fit, etc.



Basic flatness measurement program. Perfect for machine foundations, compressor housings etc.

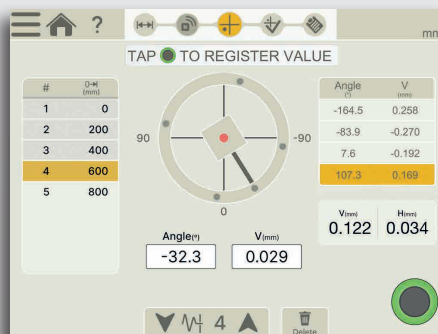

Bore center program, measuring view.

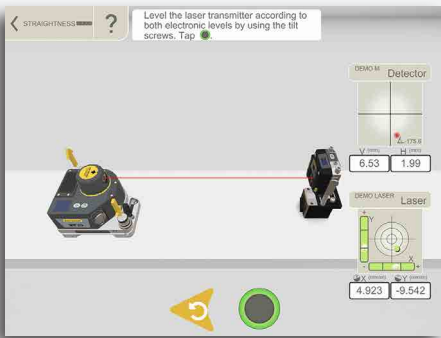

Calibrating the electronic precision levels is super easy with the step-by-step guidance provided by the software.

BORE ALIGNMENT



The Bore center program is used together with the Bore bracket kit (accessory) and its D75 laser transmitter. Either you use the XT70-M unit as detector, included with the XT770 system, or upgrade with the XT9 detector (accessory) to be able to measure smaller diameters. Different brackets can be used depending on the type of job. See next page for Bore bracket kit items.

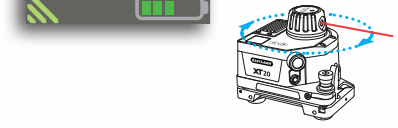

XT20 LASER TRANSMITTER

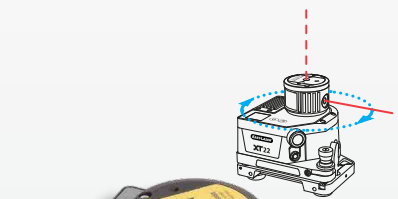

XT22 LASER TRANSMITTER



D75 LASER TRANSMITTER

CHOOSE YOUR SYSTEM!

XT770

PART NO. 12-1096

Weight: 9.1 kg [20.0 lbs]

Dimension WxHxD: 460x350x175 mm [18.1x13.8x6.9"]



XT770 GEO

WITH XT20, PART NO. 12-1128

Weight: 16.0 kg [35.3 lbs]

Dimension WxHxD: 580x460x295 mm [22.8x18.1x11.6"]

WITH XT22, PART NO. 12-1334

Weight: 16.2 kg [35.7 lbs]

Dimension WxHxD: 580x460x295 mm [22.8x18.1x11.6"]



*XT12 Display unit is added separately



BORE BRACKET KIT, WITH D75, PART NO. 12-1354

Weight: 10.2 kg [22.5 lbs]

Dimension WxHxD: 460x350x175 mm [18.1x13.8x6.9"]

BORE UPGRADE KIT, WITH XT9, PART NO. 12-1355

Weight: 0.53 kg [1.17 lbs]

All Easy-Laser® XT770 systems include:

- 1 Measuring unit XT70-M
- 1 Measuring unit XT70-S
- 2 Shaft brackets with chains and rods 120 mm [4.72"]
- 4 Rods 75 mm [2.95"]
- 4 Rods 120 mm [4.72"]
- 2 Magnet bases
- 2 Offset brackets
- 2 Extension chain 900 mm [35.4"]
- 1 Measuring tape 5 m [16.4']
- 1 Hexagon wrench set
- 1 Charger (100–240 V AC)
- 1 DC split cable for charging
- 1 DC to USB adapter, for charging
- 1 Quick reference manual
- 1 Cleaning cloth for optics
- 1 USB memory with manuals
- 1 Carrying case

Part No. 12-1128 and 12-1334 also include:

- 1 Laser transmitter XT20 or XT22
- 1 Magnet base with turnable head (replaces one of the regular magnet bases)
- 4 Rods 120 mm [4.72"]
- 1 Multi-bracket for XT20/XT22

Add display unit XT12:

Part No. 12-1292 XT12 with IR Camera

Part No. 12-1291 XT12

Both are delivered with shoulder strap Part No. 12-0997

Weight: 1490 g [52.5 oz]

Bore bracket kit includes:

- 1 Laser transmitter D75
- 1 Slide bracket Small
- 1 Slide bracket Medium
- 1 Slide bracket Large
- 1 Axial support for slide brackets
- 1 Set of rods 4x75 mm
- 1 Set of rods 4x120 mm
- 1 Set of rods 4x240 mm
- 1 Offset hub for Laser transmitter
- 1 Arms for offset hub
- 1 Bracket with rotatable bore probe
- 1 Target for detector rough alignment
- 1 Carrying case

Bore upgrade kit includes:

- 1 Detector XT9
- 1 Slide bracket 25 mm width
- 1 Rod adapter with built-in target C-C 40 mm
- 1 Rod adapter with built-in target C-C 56 mm

TECHNICAL DATA

Measuring units XT70-M / XT70-S

Type of detector	2 axis TruePSD 20x20 mm [0.79x0.79"]
Communication	BT wireless technology
Battery type	Heavy duty Li Ion rechargeable
Operating time	Up to 24 h continuously
Resolution	0.001 mm [0.05 mils]
Measurement accuracy	±1µm ±1%
Measurement range	Up to 20 m [66 feet]
Type of laser	Diode laser
Laser wavelength	630–680 nm
Laser class	Safety class 2
Laser output	<1 mW
Electronic inclinometer	0.1° resolution
Environmental protection	IP class 66 and 67
Operating temperature	-10–50 °C [14–122 °F]
Storage temperature	-20–50 °C [-4–122 °F]
Relative humidity	10–95%
OLED display	128x64 pixels
Housing material	Anodized aluminium + PC/ABS + TPE
Dimensions	WxHxD: 76x76.7x45.9 mm [3.0x3.0x1.8"]
Weight	272 g [9.6 oz]

XT12 Display unit

Type of display/size	8" LCD capacitive multi-touch colour display
Battery type	Heavy duty Li Ion rechargeable
Operating time	Up to 16 h continuously
Connections	USB A, USB C, Charger, AV
Communication	Wireless technology, WiFi
Camera, with LED diode	13 Mp autofocus
IR camera (optional)	FLIR LEPTON® (0–400 °C, 32–752 °F)
Languages	en / de / sv / es / pt / ru / ja / ko / zh / it / fr / pl / fi / tr
Help functions	Built-in manual
Environmental protection	IP66/67. Designed for outdoor use (pollution degree 4)
Operating temperature	-10–50 °C [14–122 °F]
Storage temperature	-20–50 °C [-4–122 °F]
Relative humidity	10–95%
Loudspeakers	Built-in, rear-facing
Charger	15 V
Housing material	PC/TPE or PC/TPU
Dimensions	WxHxD: 269.0x190.0x49.4 mm [10.59x7.48x1.95"]
Weight	1400 g [49.4 oz]

Cable

Charging cable (splitter cable)	Length 1 m [39.4"]
---------------------------------	--------------------

Brackets etc.

Shaft brackets	Type: V-bracket for chain, width 18 mm [0.7"]. Shaft diameters: 20–150 mm [0.8–6.0"] With extension chain, diameters up to 450 mm [17.7"] Material: anodised aluminium
Rods	Length: 120 mm, 75 mm [4.72", 2.95"] (extendable) Material: Stainless steel

Detector XT9

Type of detector	2 axis TruePSD 20x20 mm [0.79x0.79"]
Communication	BT Wireless Technology
Battery type	Heavy duty Li Ion rechargeable
Operating time	Up to 15 hours continuously
Resolution	0.001 mm [0.05 mils]
Measurement accuracy	± 1 µm ± 1%
Electronic inclinometers	0.1° resolution
Environmental protection	IP Class 66/67
Operating temperature	-10–50 °C [14–122 °F]
Storage temperature	-20–50 °C [-4–122 °F]
Relative humidity	10–95%
Housing material	Anodized aluminium, PC/ABS
Dimensions	Diameter 44 mm, L=100 mm [Diameter 1.73", L=3.93"]
Weight (excl. rod adapter)	194 g [6.8 oz]

XT20 and XT22 Laser transmitters

Type of laser	XT20: Diode laser XT22: Fiber-coupled diode laser
Laser wavelength	630–680 nm
Laser Safety Class	Class 2
Output power	< 1 mW
Beam diameter	XT20: 6 mm [0.24"] at aperture, 10 mm [0.39"] at 20 m [66'] XT22: 6 mm [0.24"] at aperture, 13 mm [0.51"] at 40 m [132']
Working range	XT20: 20 m radius [66'] XT22: 40 m radius [132']
Communication	BT Wireless technology
Warning indications	Temperature drift and shake/vibration
Connections	Charger
Type of battery	Heavy duty Li-Ion chargeable
Operating time	Up to 30 hours continuous use
Warmup time	15 min
Operating temperature	-10–50 °C [14–122 °F]
Charging temperature (battery)	0–50 °C [32–122 °F]
Storage temperature	-20–50 °C [-4–122 °F]
Relative humidity	10–95% non-condensing
Number of precision levels	XT20: 2 pcs Horizontal XT22: 2 pcs Horizontal, 1 pc Vertical
Precision level range	± 10 mm/m [± 10 mils/inch]
Precision level accuracy	± 0.02 mm/m ± 1% [± 0.02 mils/inch ± 1%]
Precision level sensitivity	0.001 mm/m [0.001 mils/inch]
Laser plane flatness	± 0.01 mm/m [± 0.01 mils/inch]
Squareness between laser beams	XT20: N/A XT22: ± 0.01 mm/m [± 0.01 mils/inch]
Laser head fine turning	XT20: 1:132 gear ratio XT22: 1:1320 gear ratio
Environmental protection	XT20: IP55, designed for outdoor use (pollution deg. 4) XT22: N/A, designed for industrial use (pollution deg. 3)
TFT display	240x240 pixels, RGB colour
Housing material	Anodized aluminium + PC/ABS + TPU
Dimensions	XT20: WxHxD: 147x126x152 mm [5.79x4.97x5.98"] XT22: WxHxD: 147x136x152 mm [5.79x5.35x5.98"]
Weight	XT20: 2065 g [72.86 oz] XT22: 2264 g [79.86 oz]

Laser transmitter D75 with offset hub

Type of laser	Diode laser
Laser wavelength	630–680 nm, visible red light
Laser Safety Class	Class 2
Output	< 1 mW
Beam diameter	6 mm [1/4"] at aperture
Working distance	40-metre [130']
Type of battery	1 x R14 (C)
Operating time/battery	approx. 15 hours
Operating temperature	0–50 °C [32–122 °F]
Laser adjustment	D75: 2 ways ±2° (± 35 mm/m), Hub: ±5 mm in two axes
Housing material	Anodized aluminium
Dimensions D75	WxHxD: 60x60x120 mm [2.36x2.36x4.72"]
Dimensions D75 with Hub	WxHxD: 135x135x167 mm [5.31x5.31x6.57"]
Weight	2385 g [84.13 lbs]

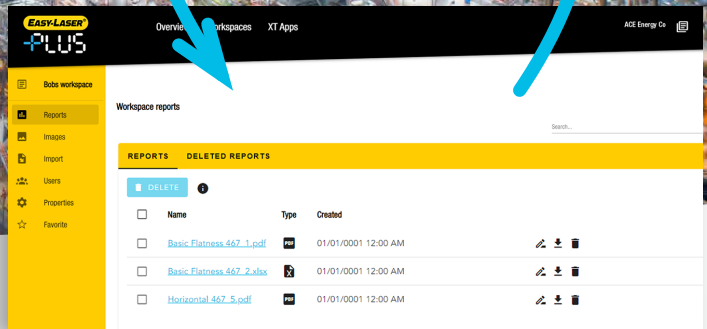
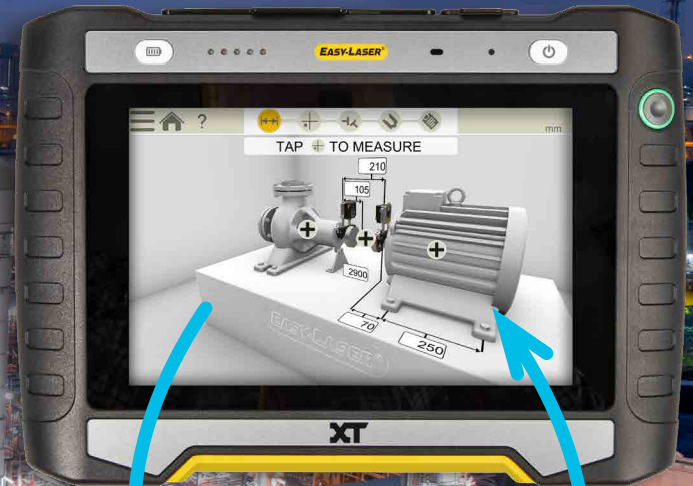
EASY-LASER[®]

Add extra power to your alignment system

...and your team!

Easy-Laser PLUS[™] is our cloud solution where you:

- ✓ Collaborate with your maintenance team on job assignments.
- ✓ Collect all your team's measurement data in one place for quick overview and analysis.
- ✓ Copy your measurement data to a new device if your tablet is lost or damaged.
- ✓ Restore accidentally deleted files on your tablet.
- ✓ Receive information about the latest software updates.

Simply put, Easy-Laser PLUS[™] is your hub for the team's measurement jobs and extra security for your data. But that's not all...

Learn more at easylaser.com!

Easy-Laser[®] is manufactured by Easy-Laser AB, Alfagatan 6, SE-431 49 Mölndal, Sweden
 Tel +46 31 708 63 00, Fax +46 31 708 63 50, e-mail: info@easylaser.com, www.easylaser.com
 © 2024 Easy-Laser AB. We reserve the right to make changes without prior notification. Easy-Laser and Easy-Laser PLUS are registered trademarks of Easy-Laser AB. Android, Google Play, and the Google Play logo are trademarks of Google Inc. Apple, the Apple logo, iPhone, and iPod touch are trademarks of Apple Inc., registered in the U.S. and other countries. App Store is a service mark of Apple Inc. Other trademarks belong to their respective owners.
 Documentation ID: 05-0914 Rev7



LASER
2



ISO
9001
CERTIFIED
COMPANY

3
YEAR
WARRANTY

